

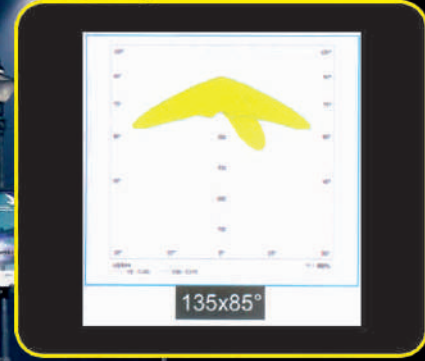

LENS POINT (INDIA) PVT. LTD.

135X85

Street Light Lens



PART NUMBER	SIZE	LED MATERIAL	LED PACKAGE	LED MANUFACTURER
LP68_8X1_3535_ 135X85°_50*50*5.4-SL24	50X50X5.4 mm	PC	3535	

General Information

Application

- Lens Material : Optical Grade PC (Bayer 2407)
- Luminous transmittance : 89 to 90%(ISO 135468-/ASTM D1003)
- Refractive index : 1.584 (ISO 489/ASTM D542)
- Operating Temperature range -40°C to 110°C (upper limit +130°C)
- Flammability : HB/V-o (UI94)
- If necessary, clean lenses with mild soap, water and soft cloth.
- ⚠ Never use any commercial cleaning solvents on lenses, like alcohol
- Please handle or install lenses with wearing gloves, skin oils may damage lens or its optical characteristics.

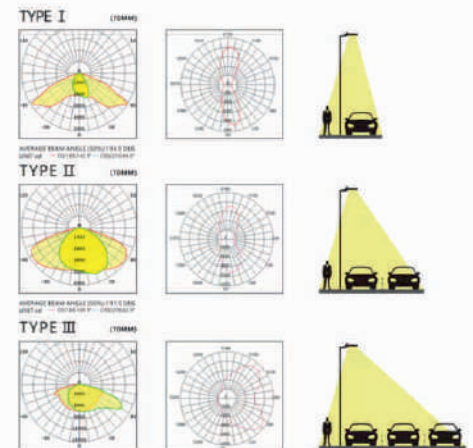

Plot No.3, Kaili Industrial Area, Main GT Road, Ballabgarh, Faridabad-121004, Haryana

+91 9711472021, 7838461601

lenspointindia@gmail.com www.lenspointindia.com

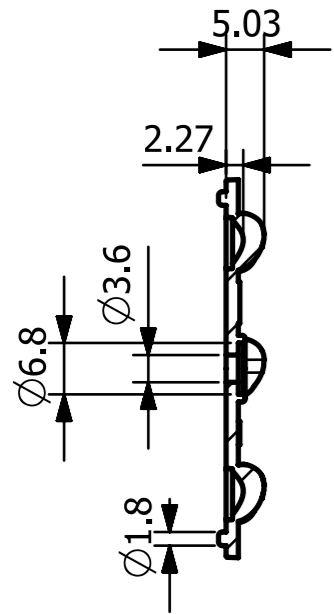

SECTION A-A

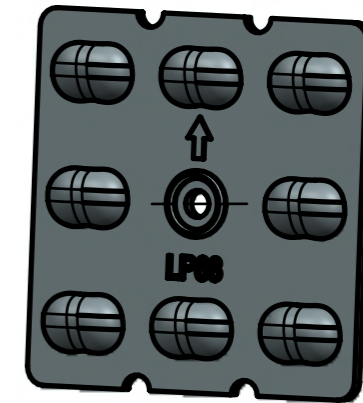
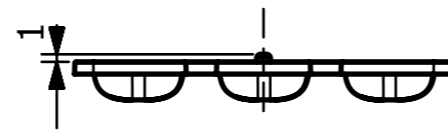
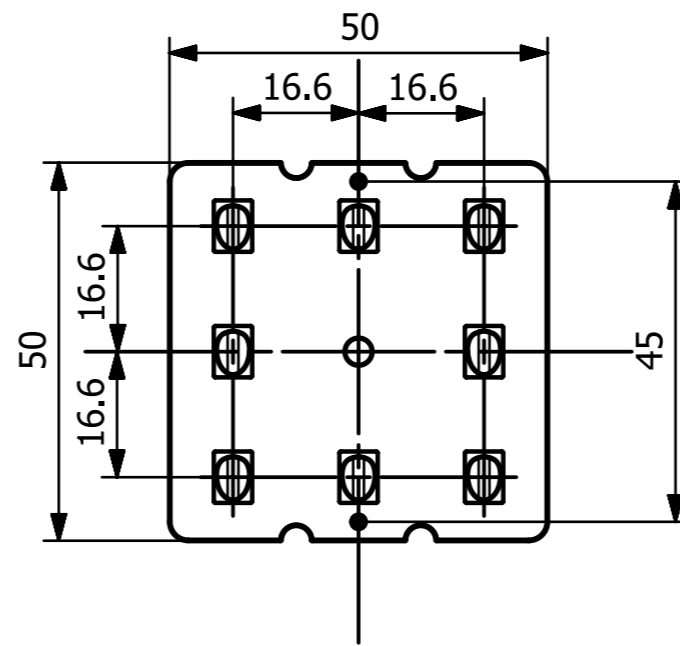
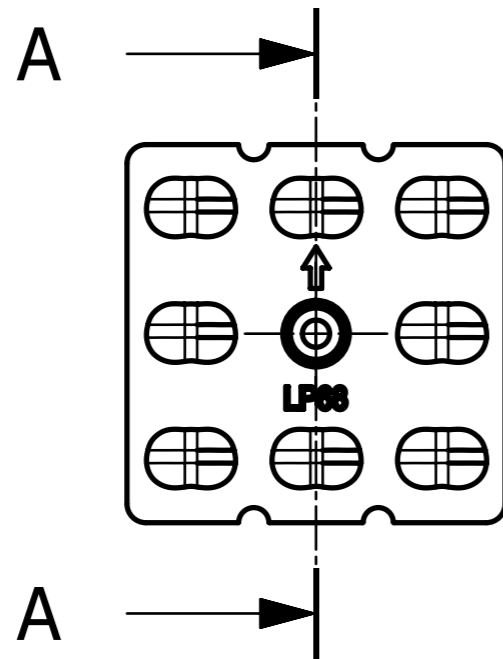

GENERAL INFO:-

1. Lens material - Optical PC
 2. Operating Temperature range -40° _ $+110^{\circ}$ (upper limit $+130^{\circ}$)
 3. Storage Temperature range -40° _ $+110^{\circ}$ (upper limit $+130^{\circ}$)
- Average Transmittance in visible spectrum 400nm-700nm > 90%
- Usage and Maintenance
1. If necessary, clean lenses with mild soap, water and soft cloth.
 2. Never use any commercial cleaning solvents like Alcohol.
 3. Handle and install lenses with wearing gloves, skin oils may Damage lenses or its optical characteristics,.



LENS POINT (INDIA) PVT. LTD.

Drawn By	AKASH	Title -LP68_8X1_3535_135X85_50*50*6.7-SL23		
Checked by	VISHAL			
Approved by		Size A3	OPEN TOL.- ± 0.2 MM	ALL DIMENSIONS ARE IN MM
Date	22-04-2022	Scale 1:1	MATERIAL - PC	