



Lens Point

# LENS POINT (INDIA) PVT. LTD.

## 135X85

### Street Light Lens

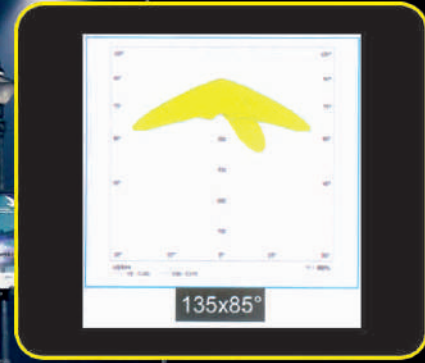
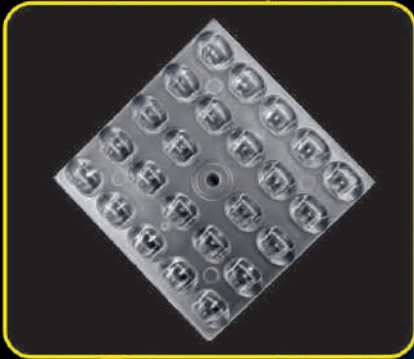

PART NUMBER	SIZE	LED MATERIAL	LED PACKAGE	LED MANUFACTURER
LP30_M_24X1_3030_135X85°_50504.2_SL10	50X50X4.2 mm	PC	3030	

#### General Information

#### Application

- Lens Material : Optical Grade PC (Bayer 2407)
- Luminous transmittance : 89 to 90%(ISO 135468-/ASTM D1003)
- Refractive index : 1.584 (ISO 489/ASTM D542)
- Operating Temperature range -40°C to 110°C (upper limit +130°C)
- Flammability : HB/V-o (UI94)
- If necessary, clean lenses with mild soap, water and soft cloth.
- ⚠ Never use any commercial cleaning solvents on lenses, like alcohol
- Please handle or install lenses with wearing gloves, skin oils may damage lens or its optical characteristics.

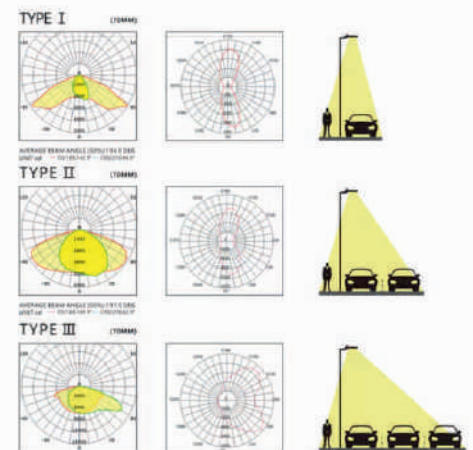

Plot No.3, Kaili Industrial Area, Main GT Road, Ballabgarh, Faridabad-121004, Haryana

+91 9711472021, 7838461601

lenspointindia@gmail.com www.lenspointindia.com

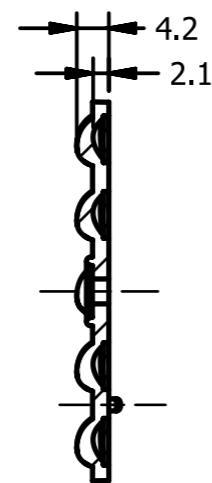
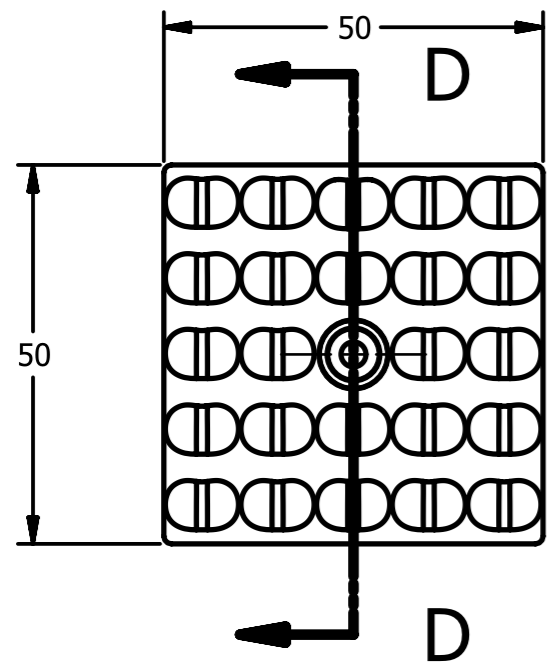

SECTION D-D

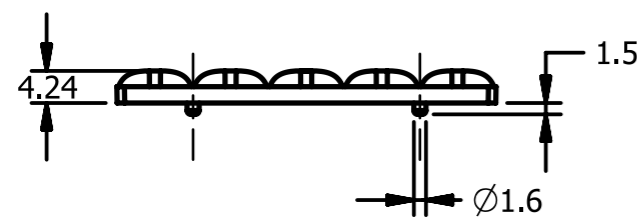
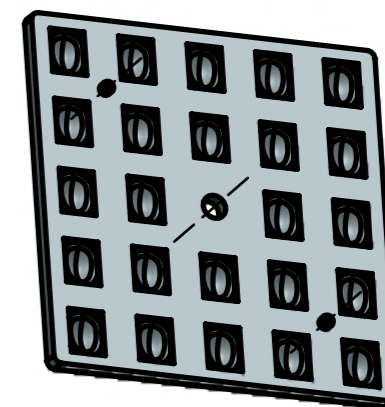
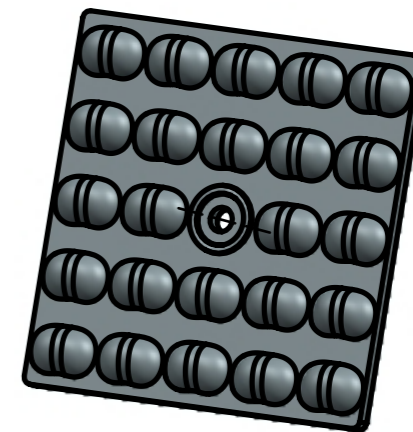
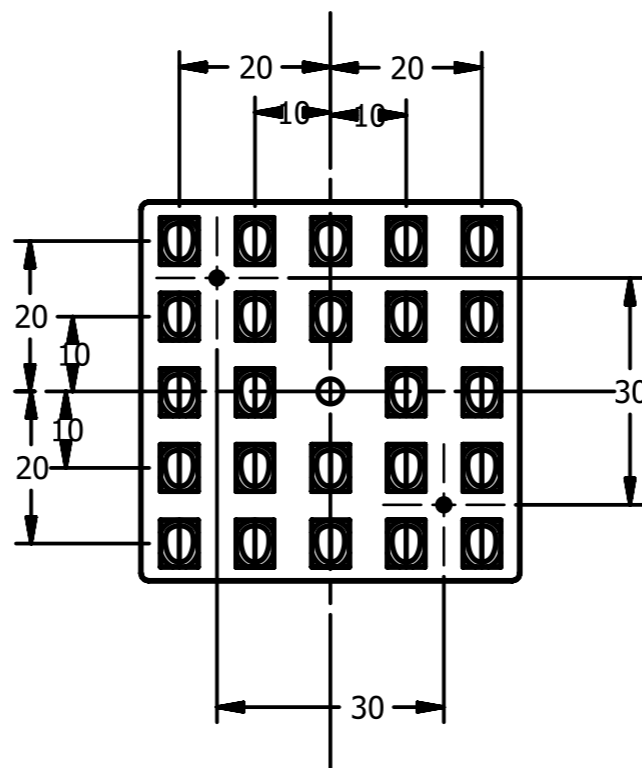

GENERAL INFO:-

1. Lens material - Optical PC
  2. Operating Temperature range  $-40^{\circ}$  \_  $+110^{\circ}$ (upper limit  $+130^{\circ}$ )
  3. Storage Temperature range  $-40^{\circ}$  \_  $+110^{\circ}$ (upper limit  $+130^{\circ}$ )
- Average Transmittance in visible spectrum 400nm-700nm>90%
- Usage and Maintenance
1. If necessary, clean lenses with mild soap, water and soft cloth.
  2. Never use any commercial cleaning solvents like Alcohol.
  3. Handle and install lenses with wearing gloves, skin oils may Damage lenses or its optical characteristics,.



LENS POINT (INDIA) PVT. LTD.

Drawn By	AKASH	Title		
Checked by	VISHAL	-LP30_M_24X1_3030_135X85°-50504.2_SL10		
Approved by		Size A3	OPEN TOL.- $\pm 0.2$ MM	ALL DIMENSIONS ARE IN MM
Date	04-03-2022	Scale 1:1	MATERIAL - PC	